

Download
Manual



🔍 Growatt New Energy

Shenzhen Growatt New Energy CO.,LTD
4-13/F,Building A,Sino-German(Europe) Industrial Park,
Hangcheng Ave, Bao'an District, Shenzhen, China

T +86 755 2747 1942

E service@ginverter.com

W www.ginverter.com

GR-UM-228-A-04

Residential Energy Storage User Manual

ARK 2.5L-A1 Battery System

Contents

About this Document

This document describes the installation, electrical connection, operation, commission, maintenance and troubleshooting of ARK 2.5L-A1 Battery System (hereafter simply put ARK 2.5L-A1). Before installing and operating ARK-2.5L-A1, ensure that you are familiar with product features, functions, and safety precautions provided in this document.

Symbol	Description
 WARNING	Indicates a potentially hazardous situation, if not avoided, could result in serious injury or death.

1 Product Overview

- 1.1 Intended Use
- 1.2 Appearance
- 1.3 Working Principle and Function

2 Safety

- 2.1 Basic security
- 2.2 Safety Precautions
- 2.3 Warning Labels
- 2.4 Emergency Responses

3 Storage and Transportation

- 3.1 Storage Requirements
- 3.2 Transportation Requirement

4 Installation

- 4.1 Installation environment
- 4.2 Basic installation requirements
- 4.3 Installation Required Tools
- 4.4 Installation Procedures
- 4.5 Electrical Connection
- 4.6 About mixing old and new batteries in parallel

5 Power on and off the Battery

- 5.1 Power On
- 5.2 Power off

6 Maintenance Guide

- 6.1 Preparation
- 6.2 PACK Replacement
- 6.3 System Failure Information List and Troubleshooting Suggestions

7 Technical Specifications

Appendix I

1 Product Overview

1.1 Intended Use

Each ARK 2.5L-A1 consists of 50Ah cells which form 51.2V voltage battery module and sixteen serial connection (1P16S). Two to ten ARK 2.5L-A1 can be connected in parallel and extend the capacity and power of energy storage system. The same type of cell and the same software version of the PACK can be used in parallel. Specifically, the ARK battery system powers the loads through PCS at nighttime without solar; when solar becomes available during daytime, solar energy powers the loads as a priority and store residual solar power into the ARK batter system.

1.2 Appearance

ARK 2.5L-A1 consists of battery module (including cell and mechanical parts), battery management system (BMS) as well as power and communication terminals. Product appearance is shown as below.

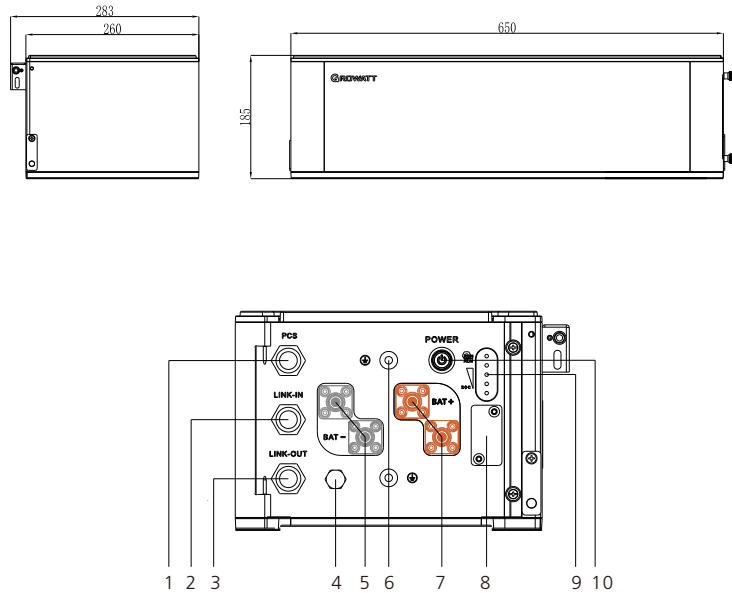

Fig 1.1: Battery dimensions and end Connector face introduction

Port function description:

Location	Port	Function
1	Communication interface	PCS CAN communication
2		LINK-IN CAN communication
3		LINK-OUT CAN communication
4	Safety vent	Balance air pressure
5	Negative terminal	Stands for PACK anode output
6	GND terminal	Terminal connect to ground
7	Positive terminal	Stands for PACK cathode output
8	USB interface	USB interface for system upgrade
9	Lamp panel	SOC and status display panel
10	Power button	Starting up

LED description:

No.	Name	Color	Description
A	LED 1	Blue	0%-25%
B	LED 2	Blue	26%-50%
C	LED 3	Blue	51%-75%
D	LED 4	Blue	76%-100%
E	RUN	Green	Normal operation
F	ALM	Red	Failure or protection status

1.3 Working Principle and Function

ARK 2.5L-A1 is an energy storage unit composed of electrochemical cells, switch button, battery management unit, power and signal terminals, and mechanical parts. It features better charge and discharge performance, more precise status monitor, longer cycle life, and less self-discharge loss than other batteries. Two to ten PACKs connected in parallel increase the capacity and power of battery system; the whole battery system communicates to Power Conversion System (PCS) via CAN.

- Monitoring: voltage, current and temperature detection of both single cells and PACK.
- Protection and Alarm: protection and alarm when overvoltage, under voltage, over current, over-temperature or under temperature occurs. See Appendix I for the details.
- Report: report all alarm and status data to PCS.
- Parallel connection: support two to ten PACKs in parallel connection.
- Passive balance function.
- Power off triggered by fault: PACK and PCS communication lost for 25 minutes or under voltage protection for 30 minutes.

2 Safety

Safety information contains in this section must be observed at all times when working on or with batteries. For safety, installers are responsibility to familiarize themselves with this manual and all warnings before installation.

2.1 Basic security

The PACK has been designed and tested in strict rules with international safety certification requirements. Read all safety instructions carefully before any work and obey the rules at all times when working on or with the PACK. Growatt shall not be liable for any consequence caused by the violation of the following:

- Damage occurred during transportation
- Incorrect transportation, storage, installation and use, or customer fails to convey the correct information about transportation, storage, installation and use to terminal customers.
- Non-professional installation
- Failure to obey the rules of this operation instructions and safety precautions in this document
- Unauthorized modifications or removal of the software package
- PACK tamper label is damaged or product with any part missing (except the authorized disassemble parts).
- Operation in extreme environments which are not allowed in this document
- Repair, disassemble, or change PACKs without authorization and cause failure.
- Damage to shell labels or modifies date of production.
- PACK fail to be charge for more than six months.
- Damages due to force majeure (such as lightning, earthquakes, fire, and storms)
- Warranty expiration.

2.2 Safety Precautions











2.2.1 Environment requirements

Do not expose the battery to temperature above 50°C or heat sources.
 Do not install or use the battery in wet locations, moisture, corrosive gases or liquids, such as bathroom.
 Do not expose the battery to direct sunlight for extended periods of time.
 Place battery in safe place away from children and animals.
 Battery power terminals shall not touch conductive objects such as wires.
 Do not dispose the batteries in fire, which may cause an explosion.
 PACK shall not come in contact with liquids.

2.2.2 Operation Precautions

Do not touch the PACK with wet hands.
 Do not disassemble the PACK without permission
 Do not crush, drop or puncture the PACK and battery.
 Dispose the batteries according to local safety regulations.
 Store and recharge battery in accordance with this manual.
 Ensure the connection of ground wire reliable.
 Remove all metal objects such as watches and rings that could cause a short-circuit before installation, replacement and maintenance.
 The Pack shall be repaired, replaced or maintained by skilled personal that has been recognized.
 When storing or handling batteries, do not stack batteries without package.
 Do not broke the battery, the released electrolyte may be toxic and is harmful to skin and eyes.
 Packaged batteries should not be stacked more than specified number stipulated on the packing case.
 Do not use damaged, failed or deformed batteries, which may lead to high temperature or even dangerous accidents. Continued operation of damaged battery may result in electrical shock, fire or even worse.

2.3 Warning Labels

Symbols	Description
	Do not dispose in trash
	Lithium ion battery can be recycled
	Certification in European union area
	Electric shock hazard
	Explosive gas
	Alternating Current (AC)
	Heavy enough to cause severe injury
	Keep the Pack away from children
	Make sure the battery polarity well connected
	Do not expose to fire
	Operate as the Manual

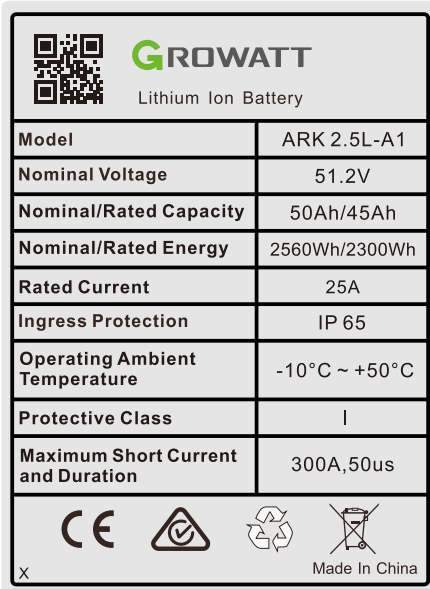

Battery Module

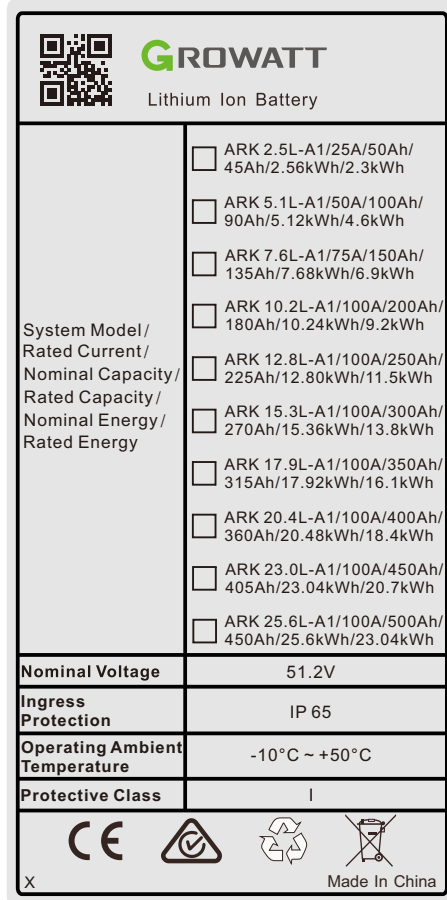

Battery System

Fig 2. 1: Nameplate

Note: When the ambient temperature is between -10 °C and 0°C, the maximum charging current of the battery is 2.5A.

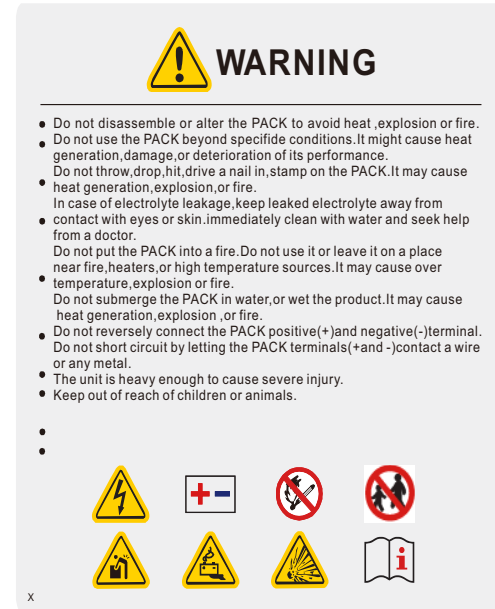

Fig 2.2: Label

2.4 Emergency Responses

Manufacturer takes foreseeable risk scenarios into consideration and is designed to reduce hazards and dangers. However, if the following situation occurs, do as below:

Situation Occurs	Description and action need
Leakage	Avoid touch of leaking liquid or gas. If you touch the leaking electrolyte, do as below immediately. Inhalation: Evacuate the contaminated area, and seek medical help. Eye contact: Rinse eyes with flowing water for 15 minutes, and seek medical help. Skin contact: Rinse contacted area thoroughly with soap and water, and seek medical help. Ingestion: Vomiting, and seek medical help.
Fire	It's hard for PACK systems ignite spontaneously. If the PACK has caught a fire, do not try to extinguish the fire but evacuate people immediately.
Wet Packs	If PACK is flooded or submerged, do not access it. Contact Growatt or distributor for technical assistance immediately.
Damaged PACKS	Damaged PACKS are dangerous and must be handled with special attention. They are no longer suitable for use and may cause danger to people. If the PACK damaged, stop use it and then contact the Growatt or distributor.

3 Storage and Transportation

3.1 Storage Requirements

- Place the PACK follow the identification on the packing case during storage.
 - Do not put the PACK upside down or sidelong.
 - The defective PACK needs to be separated from other PACKs.
 - The storage environment requirements are as follows:
Install the PACK in a dry and clean place with proper ventilation.
The storage temperature for a short week is between -20°C to 50°C.
If you store the PACK over a long period of six months, the storage temperature is between -20°C to 40°C, relative humidity: 5%~95%RH.
Place the PACK away from corrosive and organic substances (including gas exposure).
Free from direct exposure to sunlight and rain .
At least two meters away from heat sources (such as a radiator).
Free from exposure to intensive infrared radiation.
- Note:** If a PACK is useless for six months, it needs to be recharged.

Recharge procedures

1. Identify the PACK that needs recharging;
2. Refer to quick installation guidance, complete the installation and wire connection. Ensure PACK in off status during all the steps.
3. Set the power system as "CC=25A, CV=55.8V" , activate the PACK and start recharging.
4. Recharge until LED2 flicks.
5. Having completed recharge, leave circuit open for five minutes before check voltage. If voltage is not less than 52V, the recharge is successful.

3.2 Transportation Requirement

- PACK has been certified in UN38.3 (Section 38.3 of the sixth Revised Edition of the Recommendations on the Transport of Dangerous Goods: Manual of Tests and Criteria) and SN/T 0370.2-2009 (Part 2: Performance Test of the Rules for the Inspection of Packaging for Exporting Dangerous Goods). PACK is classified as category 9 dangerous goods.
- The PACK shall not be transported with other inflammable, explosive or toxic substances.
 - Ensure the original Package and label complete and recognizable.
 - Prohibit direct exposure to sunlight, rain, condensing water caused by temperature difference and mechanical damages.
 - Prohibit to pile up more than six PACKs.
 - There will be a drop in capacity during transportation and storage.
 - Transportation temperature is between -20°C to 50°C, relative humidity: 5%~95%RH.

Installation 4

 WARNING	<ul style="list-style-type: none"> ➤ Ensure to read the Guidance before installation in order to understand product information and safety cautions; ➤ Operators should be well trained technicians and fully understand the whole photovoltaic system, grid network, working principle and national regional standards; ➤ Installers must use insulating tools and wear safety equipment; ➤ Device damages caused by failure to comply with storage, transportation, installation and use requirements specified in Guidance are not covered by Warranty.
---	--

4.1 Installation environment

The ambient temperature for the installation of the battery system shall be above -10°C, below 50°C, and the humidity shall between 5% and 95%.

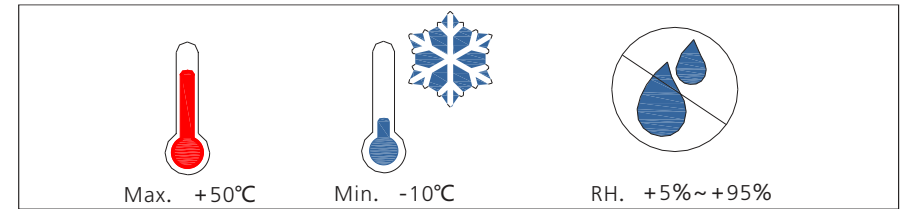

Fig 4.1: Installation environment requirements

4.2 Basic installation requirements

- The PACK can be installed indoors or outdoors. The following conditions are allowed:

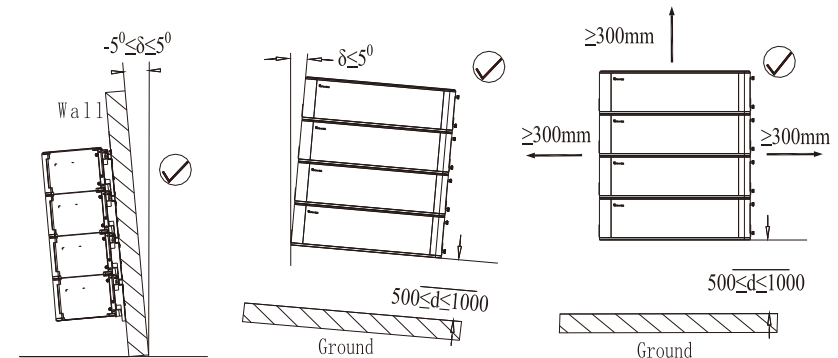

Fig 4.2: Acceptable wall mounted installation

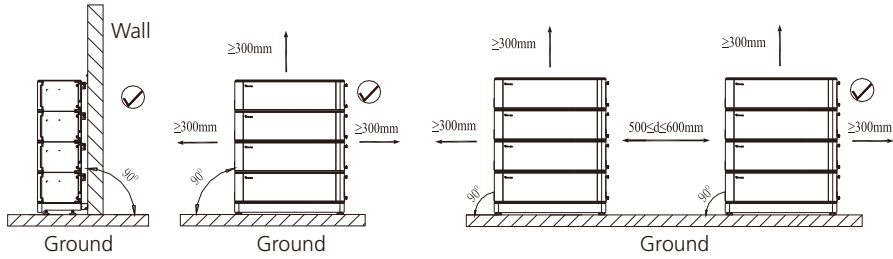

Fig 4.3: Acceptable floor standing installation

 WARNING	Do not place the PACK upside down.
--------------------	------------------------------------

➤ Build sun & rain shade to avoid direct exposure to the sunlight and rain.

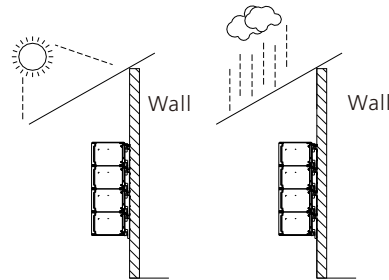

Fig 4.4: Shade for ARK 2.5L-A1

4.3 Installation Required Tools

The following tools are required to install the PACK:

 Drill	 Screw Driver	 Wrench
 Pencil	 Tap Measure	 Multimeter

It is recommended to wear the following safety gear when dealing with the PACK.

 Insulated Glove	 Safety Goggle	 Safety Shoes
---------------------	-------------------	------------------

4.4 Installation Procedures

Pre-installation Check

Check the package	Check the PACK package before open it. If any abnormality is detected, do not open the Package and contact your distributor.
Check the power	Check and confirm the PACK is powered off before installation.
Check deliverable	Check the quantity of all parts inside according to the package list. If there is any part missing or damaged, please contact your distributor.

Check the ARK 2.5L-A1

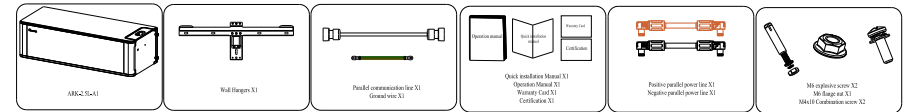
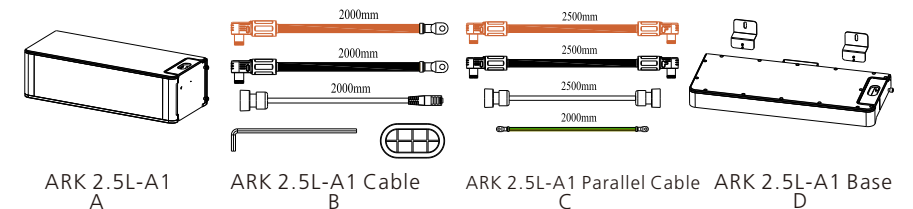

Fig 4.5: components and parts of ARK 2.5L-A1

Check the accessories



Installation Method	Compound Mode
Standard Wall-Mounted Installation	A+B
Standard floor installation	A+B+D
Wall-Mounted Battery system stacked in two line	A+B+C
Floor installation battery system stacked in two line	A+B+C+D*2

Wall Mounted Installation

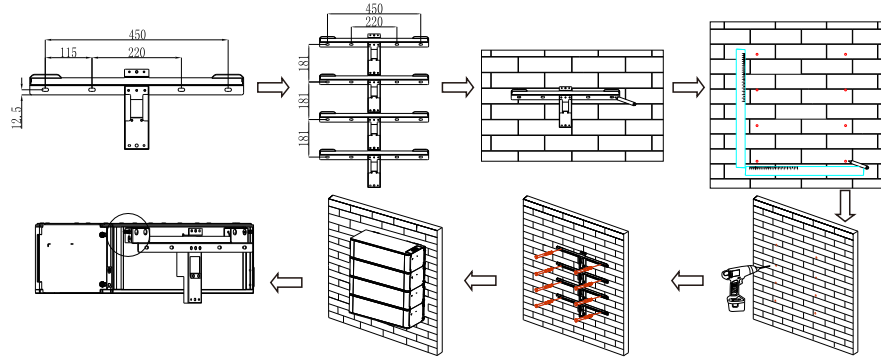

Fig 4.6: Multiple ARK 2.5L-A1 installation process

Step 1: Please make sure that the weight capacity of wall should exceed 150kg.

Step 2: Assemble the wall hangers together. If you want to install four packs, make four wall hangers together. We can parallel two to ten at a time .But, it is recommended that no more than four packs be mounted on wall.

Step 3: Place the wall hangers on the wall and mark the holes that need to be punched. We recommend two persons participate the installation. One person places the wall hangers on wall and ensure the gradienter horizontal; the other person marks the holes. Each wall hanger has two fixed positions. After mark the holes, put down the wall hangers.

Step 4: Drill a hole at the marked point with a depth of 55mm at the mark with a drill of $\phi 8$. Expand the bolt with a hammer into the hole in the wall , install the nut(including elastic flat pad)and tighten the nut with a wrench.

Step 5: Hang the ARK2.5L-A1 on the wall hangers. Adjust the battery level with M6 external hexagon torque wrench and install the safety screws (M4x10 Combination screw) on both sides of all modules.

Step 6: Plug the connected power lines into PACK terminals (red positive terminal and black negative terminal). Plug the well-connected CAN communication line into the communication ports of PCS and PACK.

Note: The number of wall-mount installations should not exceed four.

Floor Standing Installation

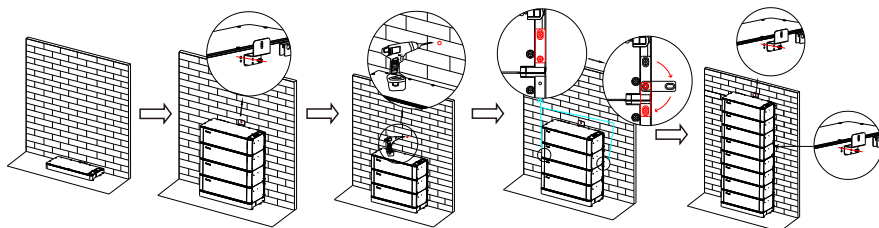

Fig 4.7: Multiple ARK 2.5L-A1 with base installation process

Step 1: Assemble the wall hangers together. If you want to install four packs, make four wall hangers together. We can parallel two to ten at a time . We recommend that the stack number be no higher than six. However, if necessary our structure allows us to stack higher.

Step 2: Place the mount base where you want the PACK to be mounted. Put the wall hangers on the wall and match the base

Step 3: Mark the holes that need to be punched. We recommend two persons participate the installation. One person places the wall hangers on wall and ensure the gradienter horizontal; the other person marks the holes. Noted that only two ends of the top wall hanger and the bottom wall hanger need to be marked. . After mark the holes, put down the wall hangers.

Step 4: Drill a hole at the marked point with a depth of 55mm at the mark with a drill of $\phi 8$. Expand the bolt with a hammer into the hole in the wall , install the nut(including elastic flat pad)and tighten the nut with a wrench.

Step 5: Hang the ARK2.5L-A1 on the wall hangers. Adjust the battery level with M6 external hexagon torque wrench and install the safety screws (M4x10 Combination screw) on both sides of all modules.

Step 6: Plug the connected power lines into PACK terminals (red positive terminal and black negative terminal). Plug the well-connected CAN communication line into the communication ports of PCS and PACK.

Note: If more than 4 batteries are used, base mounting is recommended.

For floor installation, we recommend that the number of the stacked battery modules is no higher than six.

4.5 Electrical Connection



WARNING

Do not forget wear ESD wrist strap and gloves, safety gloves and goggles.

Terminal Definition:

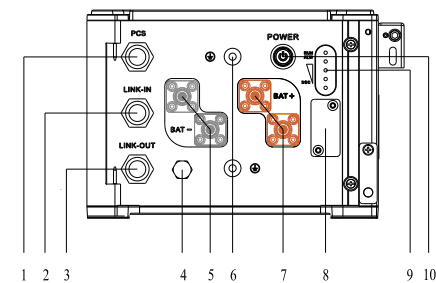



Fig 4.8: Terminal Definition

Communication interface definition:

Serial number	Item	Quantity	Specifications	Symbol
1	Communication Port	1	IP67 RJ45water proof connector	PCS
2	Communication Port	1	IP67 RJ45water proof connector	LINK-IN
3	Communication Port	1	IP67 RJ45water proof connector	LINK-OUT
4	Safety vent	1	Pressures inside released via the vent.	PCS
5	Negative terminal	2	IP67 –Black connector	BAT-
6	Grounding terminal	2	M6 Screw	⊕
7	Positive terminal	2	IP67–Red connector	BAT+
8	USB interface	1	USB interface for Program Upgrade	BAT-
9	LED	1	Five leds	BAT+
10	POWER button	1	IP67—Button to turn on or off the PACK	POWER

Item	Crystal head picture	Serial no.	Definition
PCS		1	RS485_B
		2	RS 485_A
		3	GND_COM
		4	CANH
		5	CANL
		6	GND_COM
		7	WAKE-
		8	WAKE+

4.5.1 System connection diagram

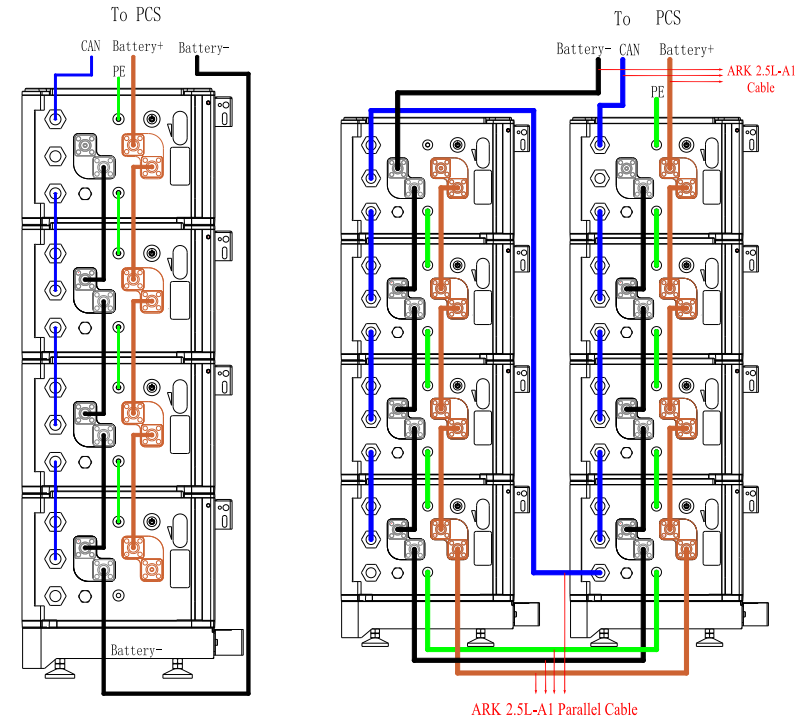

Fig 4.9: System connection diagram Fig 4.10: parallel connection stacked in two line

Note:

The battery is not allowed to be installed in the running state, and all the RUN lights of battery modules should be off before installation. To ensure system security, do not forget to install ground wire. For the power lines connected to PCS, the positive power line is drawn from the top battery module, and the negative power line is drawn from the bottom battery module. The breaker between PCS and ARK, we recommend to use molded case circuit breaker with rated working voltage greater than 500V and rated working current greater than 125A.

4.5.2 System connection diagram of two line

When stacked in two lines, you need to buy the accessory of wires connecting two stacks of battery systems. The connection mode is shown in the figure 13.

Power on and off the Battery 5

4.5.3 Electrical wiring connection

1. When the power wiring harness is connected, please pay attention to the positive and negative terminals, the red terminals are connected to the positive terminals and the black terminals to the negative terminals.
2. The PCS communication terminal is used to communicate to the PCS. Link-in terminals are used for signal inlet of multiple parallel battery packs. Link-out terminals are used for signal output of multiple parallel battery packs.

4.5.4 Power line connection

Press the position indicated in the figure above before disconnecting the power terminal.

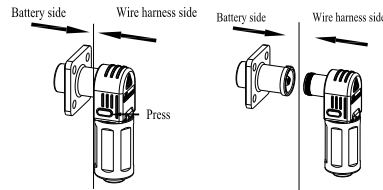

Fig 4.11: Connect and disconnect power terminals

4.5.5 Communication line connection

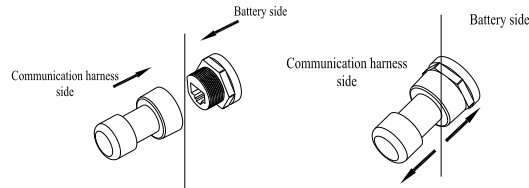



Fig 4.12: Connect and disconnect communication terminals

1. Parallel communication is the connection between the middle communication plug of the first module and the lower communication plug of the next module.
2. The uppermost communication plug of the top battery module is connected to the PCS.

4.6 About mixing old and new batteries in parallel

Please ensure batteries in parallel connection are from the same batch, same model and same manufacturer. Do not mix an old battery with a new battery. Batteries undergone less than 300 cycles are defined as new batteries. The installation time of the newly added battery and the installed battery is less than or equal to 1 year, and the newly added battery must be within the shelf life of 6 months.



WARNING

- The installation and use of batteries involve much specialized knowledge. Therefore, technicians should be given appropriate technical training and obtain operational certificates in compliance with local laws and regulations. Please ensure technicians have obtained training certificate before operation.
- Please stand on dry insulating objects and do not wear conductive material such as watches and necklace during operation. Insulated tools should be used.
- Do not contact any positions with potential difference.
- Prohibition sign should be hung on the battery: " Non - professionals, do not touch.
- If any abnormalities occur during the startup phase, power off the PACK immediately. After problem confirmed, proceed again.
- Make sure the inverter is turned off before checking the PACK.

5.1 Power On

Power on the PACK by pressing power button(t>2S)		
Serial	Procedures	Acceptation criteria
1	Connect the battery and PCS	Make sure the wiring harnesses are well connected
2	Close the breaker of the PACK	Make sure the breaker is ON
3	Press POWER button for three to eight seconds. Observe the LED indication on panel.	<ol style="list-style-type: none"> 1. If both RUN/ALM and SOC lights turn on normally, PACK is powered on successfully. 2. If RUN/ALM light turns red, there is a failure and should solve it before power on again.
Power on the PACK by PCS		
1	Connect the battery and PCS	Make sure the wiring harnesses are well connected
2	Close the breaker of the PACK	Make sure the breaker is ON
3	Power on the PCS. PCS outputs a wake up signal of 5V or an output main circuit voltage signal of 46-58V	<ol style="list-style-type: none"> 1. If both RUN/ALM and SOC lights turn on normal, PACK powers on successfully. 2. If RUN/ALM light turns red, there is a failure and should solve it before power on again.

5.2 Power off

Press the power button to turn off the PACK and five LED lights will flicker for three times. If under the situation of multiple packs in parallel, only turning off one of the packs then the whole battery system will turn off.

6 Maintenance Guide

6.1 Preparation

- Tools like safety gloves, cross head driver and socket wrench should be prepared.
- Turn off and turn on new PACK.

1. If the PACK is power-off. Press power button for 3-8 seconds to turn on.
2. If the PACK is power-on. Press power button once to turn off.

Before maintaining the battery, turn off the breaker and press power button once to make sure the PACK is in the power-off mode. Follow the installation and wire connection procedures specified above. Ensure wires are properly connected before turn the breaker on. After that, turn on the breaker and press power button of any PACK for 3-8 seconds to check if the system normal works.

6.2 PACK Replacement

- Wear safety gloves.
- Close the breaker and power off the PACK.
- Disconnect power lines and CAN communication lines of the PACK.
- Wall-mounting PACK: Uninstall the safety screws on both sides of the PACK. Lift up the PACK.
- Floor-standing PACK: Uninstall the safety part and open the connector at both ends of the battery of the batteries. Lift up the PACK.
- Put the PACK into the packing box according to the repair procedure and transport the PACK to the designated repair site.
- Install new PACK based on procedure specified in Section 4.

6.3 System Failure Information List and Troubleshooting Suggestions

Error Indication	Error description	Error cause	Suggested actions
ALM			
* (ALM Light Flickers)	Discharge under voltage protection	Single cell voltage below the threshold for under-voltage protection.	There is over discharge risk. User should stop discharging and arrange recharge
	Charge over voltage protection	Single cell voltage exceeding threshold for protection threshold.	1. There is no safety threat; 2. User should stop charging. Idle PACK and it will turn to normal status.
	External CAN Communication failure	Communication loss between PCS and PACK.	1. There is no safety threat and user should stop using battery. 2. Check if PCS and battery communication terminal is well connected. 3. If PCS and PACK cannot communicate when the communication wire is confirmed well connected, user should contact installer to repair battery.

	Interior CAN Communication failure	Communication loss between two parallel	1. Check Can connection between two batteries, CAN connection between Linkin and Linkout;
	Parallel connection failure protection	Communication failure between two parallel connected PACK	1. Check Can connection between two batteries, CAN connection between Battery and PCS;
* (ALM Light on)	Discharge short circuit	External short circuit of PACK	There is safety risk and user should stop using battery User should contact installer to repair PCS and battery
	Precharger short circuit		
	Precharger overtime circuit		
	Type inconsistency of PACK	The pack type is different	There is safety risk and user should stop using battery User should contact installer to use the same PACK in Parallel.
	Main circuit fault	BMS main power circuit failure	There is safety risk and user should stop using battery. User should contact installer to repair battery

7 Technical Specifications

Functional parameters of ARK 2.5L-G1 Energy Storage System are as shown below:

No.	Items	Specification	
1	Parallel number of Battery systems	1	2
2	Battery Module	ARK 2.5L-A1	ARK 5.1L-A1
3	Nominal Capacity/Energy	50Ah/2.56kWh	100Ah/5.12kWh
4	Rated Capacity/Energy	45Ah/2.3 kWh	90Ah/4.6 kWh
5	Rated Voltage	51.2V	
6	Operating Voltage	47.2 - 56.8V	
7	Rated Charging/discharging current	25A	50A
8	Max Charging/discharging current	48A	96A
9	Over current protection	49A	98A
10	Rated Charging/discharging power	1.28kW	2.56kW
11	Max Charging/discharging power	2.45kW	4.9kW
12	Battery Type	Cobalt Free Lithium Iron Phosphate (LFP)	
13	Operative temperature range	-10~50°C	
14	Recommended operating temperature	15°C~30°C	
15	Storage conditions	Temperature: - 20°C ~50°C / 7 days - 20°C ~40°C / 6 months Humidity: 5%~95%RH Within six months after initial charge	
16	Cooling	Natural cooling	
17	Dimension (W/D/H)	650/260/185mm	650/260/366mm
18	Weight	28kg	56kg
19	Installation	Wall-mounted installation/floor standing installation	
20	Ingress protection	IP 65	
21	Cell safety certification	IEC62619/UL1642	
22	PACK safety certification	IEC62619/IEC62040/CE/Rohs/RCM/CEC	
23	UN transportation test standard	UN38.3	
24	Communication port	CAN/RS485(Optional)	
25	Battery designation	IFpP/41/150/102/[1P16S]M/-10+50/90	IFpP/41/150/102/[(1P16S) 2P]M/-10+50/90

No.	Items	Specification	
1	Parallel number of Battery systems	3	4
2	Battery Module	ARK 7.6L-A1	ARK 10.2L-A1
3	Nominal Capacity/Energy	150Ah/7.68kWh	200Ah/10.24kWh
4	Rated Capacity/Energy	135Ah/6.9 kWh	180Ah/9.2kWh
5	Rated Voltage	51.2V	
6	Operating Voltage	47.2 - 56.8V	
7	Rated Charging/discharging current	75A	100A
8	Max Charging/discharging current	110A	110A
9	Over current protection	110A	110A
10	Rated Charging/discharging power	3.84kW	5.1kW
11	Max Charging/discharging power	5.63kW	5.63kW
12	Battery Type	Cobalt Free Lithium Iron Phosphate (LFP)	
13	Operative temperature range	-10~50°C	
14	Recommended operating temperature	15°C~30°C	
15	Storage conditions	Temperature: - 20°C ~50°C / 7 days - 20°C ~40°C / 6 months Humidity: 5%~95%RH Within six months after initial charge	
16	Cooling	Natural cooling	
17	Dimension (W/D/H)	650/260/547mm	650/260/728mm
18	Weight	84kg	112kg
19	Installation	Wall-mounted installation/floor standing installation	
20	Ingress protection	IP 65	
21	Cell safety certification	IEC62619/UL1642	
22	PACK safety certification	IEC62619/IEC62040/CE/Rohs/RCM/CEC	
23	UN transportation test standard	UN38.3	
24	Communication port	CAN/RS485(Optional)	
25	Battery designation	IFpP/41/150/102/[(1P16S) 3P]M/-10+50/90	IFpP/41/150/102/[(1P16S) 4P]M/-10+50/90

No.	Items	Specification	
1	Parallel number of Battery systems	5	6
2	Battery Module	ARK 12.8L-A1	ARK 15.3L-A1
3	Nominal Capacity/Energy	250Ah/12.8kWh	300Ah/15.36kWh
4	Rated Capacity/Energy	225Ah/11.5 kWh	270Ah/13.8 kWh
5	Rated Voltage	51.2V	
6	Operating Voltage	47.2 - 56.8V	
7	Rated Charging/discharging current	100A	100A
8	Max Charging/discharging current	110A	110A
9	Over current protection	110A	110A
10	Rated Charging/discharging power	5.1kW	5.1kW
11	Max Charging/discharging power	5.63kW	5.63kW
12	Battery Type	Cobalt Free Lithium Iron Phosphate (LFP)	
13	Operative temperature range	-10~50°C	
14	Recommended operating temperature	15°C~30°C	
15	Storage conditions	Temperature: - 20°C ~50°C / 7 days - 20°C ~40°C / 6 months Humidity: 5%~95%RH Within six months after initial charge	
16	Cooling	Natural cooling	
17	Dimension (W/D/H)	650/260/909mm	650/260/1090mm
18	Weight	140kg	168kg
19	Installation	Wall-mounted installation/floor standing installation	
20	Ingress protection	IP 65	
21	Cell safety certification	IEC62619/UL1642	
22	PACK safety certification	IEC62619/IEC62040/CE/Rohs/RCM/CEC	
23	UN transportation test standard	UN38.3	
24	Communication port	CAN/RS485(Optional)	
25	Battery designation	IFpP/41/150/102/ [(1P16S) 5P]M/ -10+50/90	IFpP/41/150/102/ [(1P16S) 6P]M/ -10+50/90

No.	Items	Specification	
1	Parallel number of Battery systems	7	8
2	Battery Module	ARK 17.9L-A1	ARK 20.4L-A1
3	Nominal Capacity/Energy	350Ah/17.92kWh	400Ah/20.48kWh
4	Rated Capacity/Energy	315Ah/16.1kWh	360Ah/18.4kWh
5	Rated Voltage	51.2V	
6	Operating Voltage	47.2 - 56.8V	
7	Rated Charging/discharging current	100A	100A
8	Max Charging/discharging current	110A	110A
9	Over current protection	110A	110A
10	Rated Charging/discharging power	5.1kW	5.1kW
11	Max Charging/discharging power	5.63kW	5.63kW
12	Battery Type	Cobalt Free Lithium Iron Phosphate (LFP)	
13	Operative temperature range	-10~50°C	
14	Recommended operating temperature	15°C~30°C	
15	Storage conditions	Temperature: - 20°C ~50°C / 7 days - 20°C ~40°C / 6 months Humidity: 5%~95%RH Within six months after initial charge	
16	Cooling	Natural cooling	
17	Dimension (W/D/H)	650/260/1271mm	650/260/1452mm
18	Weight	196kg	224kg
19	Installation	Wall-mounted installation/floor standing installation	
20	Ingress protection	IP 65	
21	Cell safety certification	IEC62619/UL1642	
22	PACK safety certification	IEC62619/IEC62040/CE/Rohs/RCM/CEC	
23	UN transportation test standard	UN38.3	
24	Communication port	CAN/RS485(Optional)	
25	Battery designation	IFpP/41/150/102/ [(1P16S) 7P]M/ -10+50/90	IFpP/41/150/102/ [(1P16S) 8P]M/ -10+50/90

No.	Items	Specification	
1	Parallel number of Battery systems	9	10
2	Battery Module	ARK 23.0L-A1	ARK 25.6L-A1
3	Nominal Capacity/Energy	450Ah/23.04kWh	500Ah/25.6kWh
4	Rated Capacity/Energy	405Ah/20.7 kWh	450Ah/23.0 kWh
5	Rated Voltage	51.2V	
6	Operating Voltage	47.2 - 56.8V	
7	Rated Charging/discharging current	100A	100A
8	Max Charging/discharging current	110A	110A
9	Over current protection	110A	110A
10	Rated Charging/discharging power	5.1kW	5.1kW
11	Max Charging/discharging power	5.63kW	5.63kW
12	Battery Type	Cobalt Free Lithium Iron Phosphate (LFP)	
13	Operative temperature range	-10~50°C	
14	Recommended operating temperature	15°C~30°C	
15	Storage conditions	Temperature: - 20°C ~50°C / 7 days - 20°C ~40°C / 6 months Humidity: 5%~95%RH Within six months after initial charge	
16	Cooling	Natural cooling	
17	Dimension (W/D/H)	650/260/1633mm	650/260/1814mm
18	Weight	252kg	280kg
19	Installation	Wall-mounted installation/floor standing installation	
20	Ingress protection	IP 65	
21	Cell safety certification	IEC62619/UL1642	
22	PACK safety certification	IEC62619/IEC62040/CE/Rohs/RCM/CEC	
23	UN transportation test standard	UN38.3	
24	Communication port	CAN/RS485(Optional)	
25	Battery designation	IFpP/41/150/102/ [(1P16S) 9PJM/ -10+50/90	IFpP/41/150/102/ [(1P16S) 10PJM/ /-10+50/90

Appendix I

LED indication Control Mechanism

LED light definition							
Status	Items	SOC indication				RUN/ALM	Remark
		LED1	LED2	LED3	LED4	LED5	
Charge SOC	0%-25%	✱(t=1S)				●	RUN/ALM light on and one SOC lights flicker
	26%-50%	●	✱(t=1S)			●	
	51%-75%	●	●	✱(t=1S)		●	
	76%-99%	●	●	●	(t=1S)	●	
	100%	●	●	●	●	●	
Discharge SOC	100%-76%	●	●	●	●	●	
	75%-51%	●	●	●		●	
	50%-26%	●	●			●	
	25%-5%	●				●	
	5%-0%	●				✱(t=1S)	RUN/ALM light flicker
Idle	100%-76%	●	●	●	●	●	
	75%-51%	●	●	●		●	
	50%-26%	●	●			●	
	25%-5%	●				●	
	5%-0%	●				✱(t=1S)	RUN/ALM light flicker
Parallel connection	Parallel connection succeeds	✱	✱	✱	✱	●	RUN/ALM light flicker green
Protection	Cell charge overvoltage alarm	LED1-LED4 indicates current remaining capacity				✱(t=1S)	RUN/ALM light flicker green
	Cell charge overvoltage protection					✱(t=1S)	RUN/ALM light flicker green
	PACK charge overvoltage alarm					✱(t=1S)	RUN/ALM light flicker green
	PACK charge overvoltage protection					✱(t=1S)	RUN/ALM light flicker green
	Over charge and over discharge alarm					✱(t=1S)	RUN/ALM light flicker green

Over charge and over discharge protection	(t=1S)	RUN/ALM light flicker green
Charging current limit does not respond	(t=1S)	RUN/ALM light flicker green
Charge and discharge high temperature alarm	(t=1S)	RUN/ALM light flicker green
Charge and discharge high temperature protection	(t=1S)	RUN/ALM light flicker green
Charge and discharge low temperature alarm	(t=1S)	RUN/ALM light flicker green
Charge and discharge low temperature protection	(t=1S)	RUN/ALM light flicker green
Cell discharge undervoltage alarm	(t=1S)	RUN/ALM light flicker green
Cell discharge undervoltage protection	(t=1S)	RUN/ALM light flicker green
PACK discharge undervoltage alarm	(t=1S)	RUN/ALM light flicker green
PACK discharge undervoltage protection	(t=1S)	RUN/ALM light flicker green
Charge and discharge Overcurrent hardware protection	(t=1S)	RUN/ALM light flicker green

Mos high temperature alarm	(t=1S)	RUN/ALM light flicker green		
Mos high temperature protection	(t=1S)	RUN/ALM light flicker green		
High temperature environment alarm	(t=1S)	RUN/ALM light flicker green		
High temperature environment protection	(t=1S)	RUN/ALM light flicker green		
Cell Large voltage difference alarm	(t=1S)	RUN/ALM light flicker green		
Cell Large voltage difference protection	(t=1S)	RUN/ALM light flicker green		
difference protection between PACK voltage and module voltage	(t=1S)	RUN/ALM light flicker green		
Parallel connection over charge and over discharge alarm	(t=1S)	RUN/ALM light flicker green		
Fault, personnel handling required	LED1-LED4 indicates current remaining capacity	Discharge short circuit	(t=1S)	RUN/ALM light flicker red
		Precharged short circuit	(t=1S)	RUN/ALM light flicker red
		Precharged overtime circuit	(t=1S)	RUN/ALM light flicker red
		External CAN communication failure	(t=1S)	RUN/ALM light flicker red
		Interior CAN communication failure	(t=1S)	RUN/ALM light flicker red
		Parallel connection failure	(t=1S)	RUN/ALM light flicker red

Type inconsistency of PACK	✱(t=1S)	RUN/ALM light flicker red
Batteries failure protection	●	RUN/ALM light stays red
Voltage sampling anomaly protection	●	RUN/ALM light stays red
Current sampling fault	●	RUN/ALM light stays red
Main circuit fault	●	RUN/ALM light stays red

Method for calculating rated capacity:

Rated capacity of the measured module: 45 Ah

Number of modules connected in parallel: 10

Calculated rated capacity (Ah) = 45 Ah×N = 45*N Ah (N=1~10)

Recommend charging method declared by the manufacturer:

1. Constant current 25*N A charging to 54V (Max does not exceed 100A) ;

2. Constant current 10*N A charging to 55V (Max does not exceed 100A) ;

3. Constant current 2*N A charging to 55V;

Battery designation :

IFpP/41/150/102/[(1P16S) NP]M/-10+50/90

Note: N=1 ~ 10

The low-voltage battery has no other measures to disconnect the circuit except MOSFET. It can only rely on communication to inform the external PCS to realize the charging stop function.

Shenzhen Growatt New Energy CO.,LTD

4-13/F, Building A, Sino-German(Europe) Industrial Park,
Hangcheng Ave, Bao'an District, Shenzhen, China

T +86 755 2747 1942

E service@ginverter.com

W www.ginverter.com